

# AmmoLyt<sup>®</sup> *Plus* 700 IQ

MODULAR SENSOR FOR AMMONIUM AND NITRATE



a xylem brand



For the most recent version of the manual, please visit [www.yssi.com](http://www.yssi.com).

**Contact**

YSI  
1725 Brannum Lane  
Yellow Springs, OH 45387 USA  
Tel: +1 937-767-7241  
800-765-4974  
Email: [environmental@ysi.com](mailto:environmental@ysi.com)  
Internet: [www.yssi.com](http://www.yssi.com)

**Copyright**

© 2016 Xylem Inc.

## Contents

<b>1</b>	<b>Overview</b> .....	<b>5</b>
1.1	How to use this component operating manual .....	5
1.2	Structure of the sensor AmmoLyt <sup>®Plus</sup> 700 IQ .....	6
1.3	Recommended fields of application .....	7
<b>2</b>	<b>Safety</b> .....	<b>9</b>
2.1	Safety information .....	9
2.1.1	Safety information in the operating manual .....	9
2.1.2	Safety signs on the product .....	9
2.1.3	Further documents providing safety information ..	9
2.2	Safe operation .....	10
2.2.1	Authorized use .....	10
2.2.2	Requirements for safe operation .....	10
2.2.3	Unauthorized use .....	10
<b>3</b>	<b>Commissioning</b> .....	<b>11</b>
3.1	Scopes of delivery .....	11
3.2	IQ SENSORNET system requirements .....	11
3.3	Notes on the handling of the electrodes .....	12
3.3.1	Effects to be generally avoided .....	12
3.3.2	Reference electrode .....	13
3.3.3	Measurement electrodes and compensation electrodes .....	14
3.4	Getting the sensor ready for measuring .....	15
3.4.1	Equipping the sensor with electrodes .....	15
3.4.2	Mounting the protective hood .....	16
3.4.3	Connecting the sensor to the IQ SENSORNET ..	17
3.5	Settings .....	19
3.5.1	General information .....	19
3.5.2	Setting table <i>AmmoLyt+</i> (ammonium sensor) ..	20
3.5.3	Setting table <i>AmmoLyt+K</i> (potassium sensor) ..	22
<b>4</b>	<b>Matrix adjustment, check and calibration</b> .....	<b>24</b>
4.1	General information .....	24
4.2	Matrix adjustment .....	25
4.2.1	General information on matrix adjustment .....	25
4.2.2	Carrying out the matrix adjustment .....	25
4.2.3	Result of the matrix adjustment .....	26
4.2.4	Special functions .....	27
4.3	Check and calibration in standard solutions .....	27
4.3.1	General information on checking and calibrating	27

---

4.3.2	Result of the check .....	30
4.3.3	Result of the calibration .....	30
4.4	Sensor history .....	31
<b>5</b>	<b>Measuring .....</b>	<b>34</b>
5.1	Measurement operation .....	34
5.2	Factors affecting the measured value .....	34
<b>6</b>	<b>Maintenance and electrode exchange .....</b>	<b>35</b>
6.1	General maintenance instructions .....	35
6.2	Exterior cleaning .....	35
6.3	Exchanging the electrodes .....	37
<b>7</b>	<b>Replacement parts and accessories .....</b>	<b>38</b>
7.1	Electrodes .....	38
7.2	General accessories .....	38
<b>8</b>	<b>What to do if ... ..</b>	<b>40</b>
8.1	Interpretation of the drift voltage .....	40
8.2	Error causes and remedies .....	41
<b>9</b>	<b>Technical data .....</b>	<b>44</b>
9.1	Measuring characteristics .....	44
9.2	Application conditions .....	46
9.3	General data .....	46
9.4	Electrical data .....	47
9.5	Data of the VARiON®Plus electrodes .....	48
9.5.1	Response times .....	48
9.5.2	Materials .....	48
9.5.3	Weights .....	48
<b>10</b>	<b>Contact Information .....</b>	<b>49</b>
10.1	Ordering & Technical Support .....	49
10.2	Service Information .....	49
<b>11</b>	<b>Indexes .....</b>	<b>50</b>
11.1	Explanation of the messages .....	50
11.1.1	Error messages .....	50
11.1.2	Informative messages .....	50
11.2	Status info .....	51

# 1 Overview

## 1.1 How to use this component operating manual

### Structure of the IQ SENSORNET operating manual

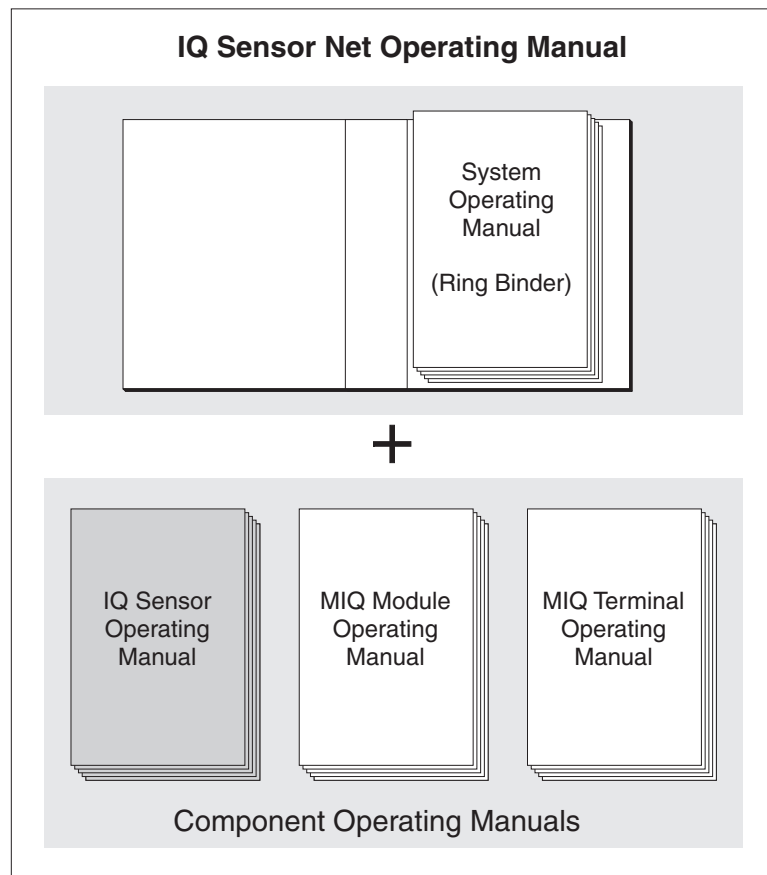

Fig. 1-1 Structure of the IQ SENSORNET operating manual

The IQ SENSORNET operating manual has a modular structure like the IQ SENSORNET itself. It consists of a system operating manual and the operating manuals of all the components used.

Please file this component operating manual in the ring binder of the system operating manual.

## 1.2 Structure of the sensor AmmoLyt<sup>®Plus</sup> 700 IQ



Fig. 1-2 Structure of the sensor AmmoLyt<sup>®Plus</sup> 700 IQ

1	Protective hood
2	Temperature sensor
3	Electrode support with electrodes (sample equipment)
4	Sensor shaft
5	Plug head connector

### Electrodes

For a AmmoLyt<sup>®Plus</sup> 700 IQ sensor ready to measure, a jointly used reference electrode and at least one ion sensitive electrode for the main measured parameter (ammonium) is required. The electrodes are screwed into the electrode support. The electrode support has three receptacles for this.

### Automatic interfering ions compensation

The AmmoLyt<sup>®Plus</sup> 700 IQ enables the automatic interfering ions compensation for the main measured parameter. Thus the influence of interfering ions due to measuring technique can be automatically compensated for.

For ammonium measurement, the main interfering ion in water / waste-water-applications is potassium. To determine the interfering ions concentration, another electrode (compensation electrode) is mounted into a free receptacle.



Information on the fundamentals of measuring with ion sensitive electrodes is given in the primer, ION SELECTIVE MEASUREMENT IN ONLINE ANALYSIS.

**Operating modes and electrode equipment**

Due to its modular structure, the AmmoLyt<sup>®Plus</sup> 700 IQ can be adapted to various requirements (see table on the following page).

Notes on the table:

The reference electrode has an extra receptacle marked by a recess. The ion sensitive electrodes can be mounted in the remaining three receptacles in any order. Empty receptacles have to be closed with the VARiON<sup>®</sup> BP blind plug.

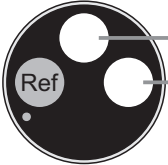
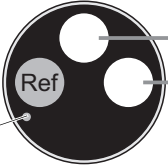
Operating mode	Electrode equipment
Ammonium measurement	 <p>VARiON<sup>®</sup> Ref</p> <p>VARiON<sup>®Plus</sup> NH4</p> <p>Blind plug</p>
Ammonium measurement, compensated	 <p>VARiON<sup>®</sup> Ref (recess)</p> <p>VARiON<sup>®Plus</sup> NH4</p> <p>VARiON<sup>®Plus</sup> K</p>

**Calibration free operation**

The AmmoLyt<sup>®Plus</sup> 700 IQ sensor is immediately ready to measure after being equipped with electrodes. For precise measurements, it is only necessary to adjust the electrodes to the sample matrix ("matrix adjustment"). In the recommended application (see section 1.3 RECOMMENDED FIELDS OF APPLICATION), the measuring characteristics of the electrodes remain stable for their entire service life. Thus, calibration is not recommended.

Possible changes of the sample matrix can be determined by occasional comparison measurements (e.g. photometer) and compensated for by a new matrix adjustment as necessary. The sensor does not have to be taken out of the sample for this.

**Shielding of the AmmoLyt<sup>®Plus</sup> 700 IQ**

The AmmoLyt<sup>®Plus</sup> 700 IQ sensor and the corresponding electrodes in conjunction with the IQ SENSORNET system form a measuring system that is protected to a high degree against low and high frequency interference as well as against the indirect effects of lightning strikes.

**1.3 Recommended fields of application**

The AmmoLyt<sup>®Plus</sup> 700 IQ sensor is a sensor for the online determination of ammonium ions in water or wastewater applications. It supple-

ments D. O. measurement in the aeration tank of waste water treatment plants and enables an efficient process control of nitrogen removal.



More detailed information on measuring with ion sensitive electrodes is given in the primer, ION SELECTIVE MEASUREMENT IN ONLINE ANALYSIS.



## 2 Safety

### 2.1 Safety information

#### 2.1.1 Safety information in the operating manual

This operating manual provides important information on the safe operation of the product. Read this operating manual thoroughly and make yourself familiar with the product before putting it into operation or working with it. The operating manual must be kept in the vicinity of the sensor so you can always find the information you need.

Important safety instructions are highlighted in this operating manual. They are indicated by the warning symbol (triangle) in the left column. The signal word (e.g. "CAUTION") indicates the level of danger:



#### **WARNING**

**indicates a possibly dangerous situation that can lead to serious (irreversible) injury or death if the safety instruction is not followed.**



#### **CAUTION**

**indicates a possibly dangerous situation that can lead to slight (reversible) injury if the safety instruction is not followed.**

#### **NOTE**

*indicates a situation where goods might be damaged if the actions mentioned are not taken.*

#### 2.1.2 Safety signs on the product

Note all labels, information signs and safety symbols on the product. A warning symbol (triangle) without text refers to safety information in this operating manual.

#### 2.1.3 Further documents providing safety information

The following documents provide additional information, which you should observe for your safety when working with the measuring system:

- Operating manuals of other components of the measuring system (power packs, controller, accessories)
- Safety datasheets of calibration and maintenance equipment (e.g. cleaning solutions).

## 2.2 Safe operation

### 2.2.1 Authorized use

The authorized use of the AmmoLyt<sup>®Plus</sup> 700 IQ consists of its use as a sensor in the IQ SENSORNET. Only the operation and running of the sensor according to the instructions and technical specifications given in this operating manual is authorized (see chapter 7 TECHNICAL DATA). Any other use is considered unauthorized.

### 2.2.2 Requirements for safe operation

Note the following points for safe operation:

- The product may only be operated according to the authorized use specified above.
- The product may only be supplied with power by the energy sources mentioned in this operating manual.
- The product may only be operated under the environmental conditions mentioned in this operating manual.
- The product may not be opened.

### 2.2.3 Unauthorized use

The product must not be put into operation if:

- it is visibly damaged (e.g. after being transported)
- it was stored under adverse conditions for a lengthy period of time (storing conditions, see chapter 7 TECHNICAL DATA).

### 3 Commissioning

#### 3.1 Scopes of delivery

The AmmoLyt<sup>®Plus</sup> 700 IQ sensor is provided in sets for different measurement requirements. Each set contains the following components:

- Unequipped sensor AmmoLyt<sup>®Plus</sup> 700 IQ. The electrode receptacles are closed with blind plugs
- Reference electrode VARiON<sup>®Plus</sup> Ref
- Depending on the set, the suitable selection from the following measurement and compensation electrodes:
  - VARiON<sup>®Plus</sup> NH4 (ammonium electrode)
  - VARiON<sup>®Plus</sup> K (potassium electrode for compensation)
- Special socket wrench
- VARiON<sup>®</sup> 700 IQ-SK protective hood
- Potassium chloride solution for storing the reference electrode
- Operating manual



Information on the available sets is given in the YSI catalog and on the Internet.

#### 3.2 IQ SENSORNET system requirements

##### Software versions of the controller and terminal components

Operation of the AmmoLyt<sup>®Plus</sup> 700 IQ requires the following software statuses in the IQ SENSORNET, depending on the system:

- |                  |                                     |                        |
|------------------|-------------------------------------|------------------------|
| ● MIQ/MC2        | Software:                           | Version 3.35 or higher |
| ● MIQ/TC 2020 XT | Simplified operation from software: | Version 3.60 or higher |
| ● DIQ/S 182      | Software:                           | Version 3.21 or higher |
| ● MIQ/C184 (XT)  | Controller software:                | Version 2.83 or higher |
|                  | Terminal software:                  | Version 2.91 or higher |

- |                       |  |                                   |
|-----------------------|--|-----------------------------------|
| ● MIQ/MC              | Controller software:                               | Version 2.83<br>or higher         |
| ● MIQ/T 2020 (PLUS)   | Terminal software:                                 | Version 2.91<br>or higher         |
| ● IQ-LabLinkprocedure | Software:<br>(AmmoLyt <sup>®Plus</sup> 700 IQ<br>) | Version 3.06 to ver-<br>sion 3.25 |

### 3.3 Notes on the handling of the electrodes

The electrodes of the AmmoLyt<sup>®Plus</sup> 700 IQ sensor were developed for the rough use in waste water treatment plants. They are, however, precision parts that can be damaged by inappropriate use.

#### 3.3.1 Effects to be generally avoided

Avoid the following effects that can adversely affect the measurement characteristics of the electrodes or reduce their lifetime:

- Drying-up of the electrode membrane and junction
- Scratching of the electrode membrane and junction
- Contact with fat, oil, alcohol, acids, lyes, tensides and similar substances
- Cleaning with washing-up liquid (tenside!)
- Cleaning with or storing in deionized water
- Storing in wrong storing solution

Therefore, exactly follow the instructions in the two following chapters.

### 3.3.2 Reference electrode

#### Commissioning

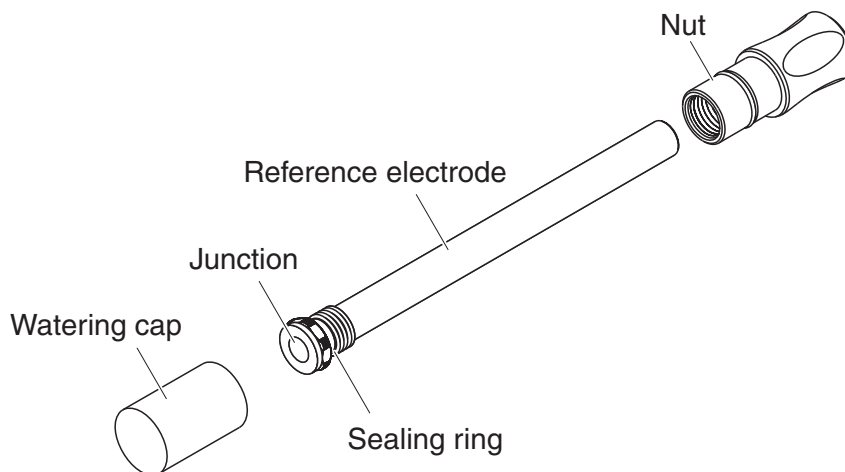

Fig. 3-1 Reference electrode with storing aids

In the delivery condition, the electrode is equipped with a watering cap and a nut that protects the screw-in thread. The watering cap contains 3 mol/l potassium chloride solution. Before mounting, unscrew the watering cap. Then, using the special hexagon key, unscrew the electrode from the nut. Keep both storing aids in case you want to store the electrode.



The junction of the reference electrode must not

- dry up (follow notes on storage)
- be damaged
- be brought into contact with grease.

#### Notes on storage

If you will not use the electrode for a longer period of time, screw the electrode into the nut as far as it will go. Fill the watering cap to the brim with 3 mol/l potassium chloride solution and tightly screw the watering cap on the electrode by hand.

### 3.3.3 Measurement electrodes and compensation electrodes

#### Commissioning

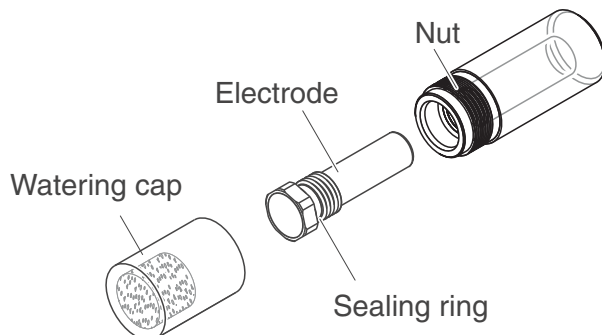

Fig. 3-2 Measurement or compensation electrode with storing aids

In the delivery condition, each electrode is equipped with a watering cap and a nut that protects the screw-in thread. Prior to installation, first remove the watering cap and, using the special hexagon key, unscrew the electrode from the nut. Keep both storing aids in case you want to store the electrode.



The membrane of the electrode must not

- dry up (follow notes on storage)
- be damaged
- be brought into contact with grease.

#### Notes on storage

If you will not use the electrode for a longer period of time, screw the electrode into the nut as far as it will go. Soak the foam insert in the watering cap with VARiON®/ES-1 standard solution (lower concentration) and plug the electrode into the watering cap.

#### NOTE

*Make sure to use the correct solution for the watering cap (VARiON®/ES-1 standard solution). If you use the watering solution of the reference electrode instead the function of the electrode can be seriously damaged.*

### 3.4 Getting the sensor ready for measuring

#### 3.4.1 Equipping the sensor with electrodes

**NOTE**

The sensor can be damaged by dirt and moisture. Before mounting the electrodes make sure the area behind the sealing ring of the electrodes and the receptacle are dry and clean. The AmmoLyt<sup>®Plus</sup> 700 IQ may only be submersed when the electrodes or original blind plugs are mounted.



More detailed information on the electrode equipment for the various operating modes is given in chapter 1.2.

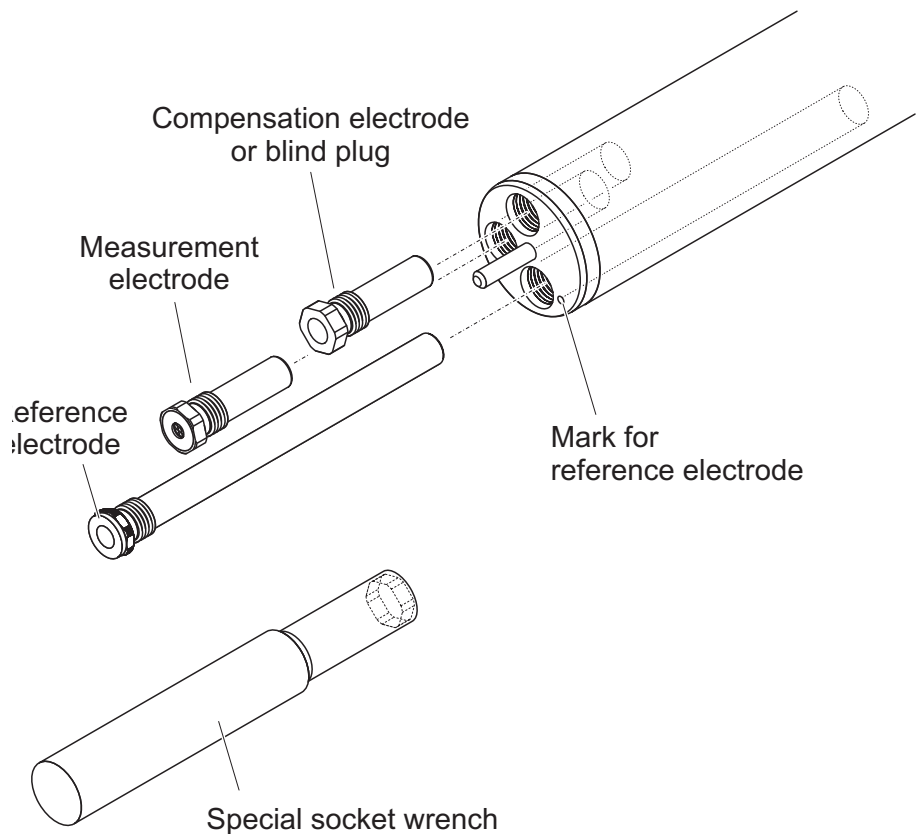

Fig. 3-3 Equipping the sensor with electrodes.

All receptacles are closed with blind plugs in the delivery condition. Screw the electrodes into the receptacles instead of the blind plugs.

When doing so observe the following points:

- The receptacle for the reference electrode is marked by a recess. It extends into the inside of the sensor clearly deeper than the other three receptacles (see Fig. 3-3).

- The measurement and compensation electrodes can be mounted in the remaining three receptacles in any order.
- During installation make sure the area behind the sealing ring of the electrode and the receptacle are absolutely dry and clean.
- Plug the electrode on the special socket wrench provided and insert the electrode with the special socket wrench.
- Screw until the electrode is seated on the electrode support without any gap. Thus the tightness and electrical contacting are granted.



When mounted, the electrodes can be recognized by the features described in section 6.3.

### 3.4.2 Mounting the protective hood

#### CH cleaning head (option)

For permanent operation, we recommend to use the CH cleaning head for compressed air-driven cleaning. It is mounted instead of the standard protective hood. The compressed air cleaning is started time-controlled via the IQ SENSORNET system. Information on the required components is given in the catalog and on the Internet.

If no CH cleaning head is used the standard protective hood should always be mounted for measuring. It protects the electrodes from rough mechanical impact.

#### Mounting the standard protective hood

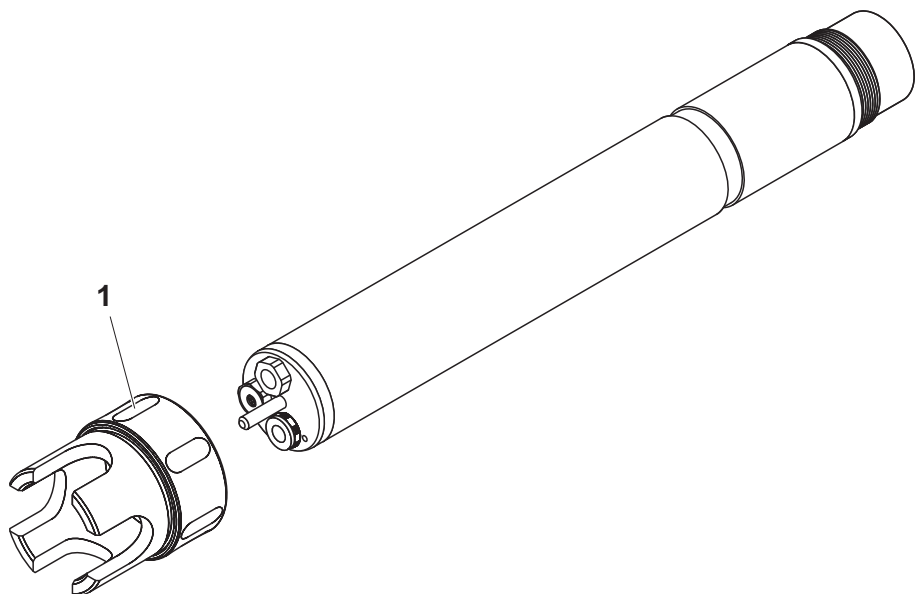

Fig. 3-4 Mounting the standard protective hood.



1	Loosen the coupling ring (1) of the protective hood.
2	Push the protective hood on the sensor as far as it will go.
3	Tighten the coupling ring of the protective hood.

**Cleaning the protective hood**

The coupling ring of the protective hood can be taken apart for cleaning purposes (see section 6.2 EXTERIOR CLEANING).

**3.4.3 Connecting the sensor to the IQ SENSORNET**

**Connection cable**

The SACIQ sensor connection cable is required to connect the sensor. Information on this and other IQ SENSORNET accessories is given in the catalog and on the Internet.



Do not suspend the sensor on the sensor connection cable. Use an armature or electrode holder. Information on this and other IQ SENSORNET accessories is given in the catalog and on the Internet.



How to connect the SACIQ sensor connection cable to the IQ SENSORNET is described in chapter 3 INSTALLATION of the IQ SENSORNET system operating manual.

**Are the plug connections dry?**

Before connecting the sensor and sensor connection cable, make sure that the plug connections are dry. If moisture gets into the plug connections, first dry the plug connections (dab them dry or blow them dry using compressed air).

### Connecting the sensor to the sensor connection cable

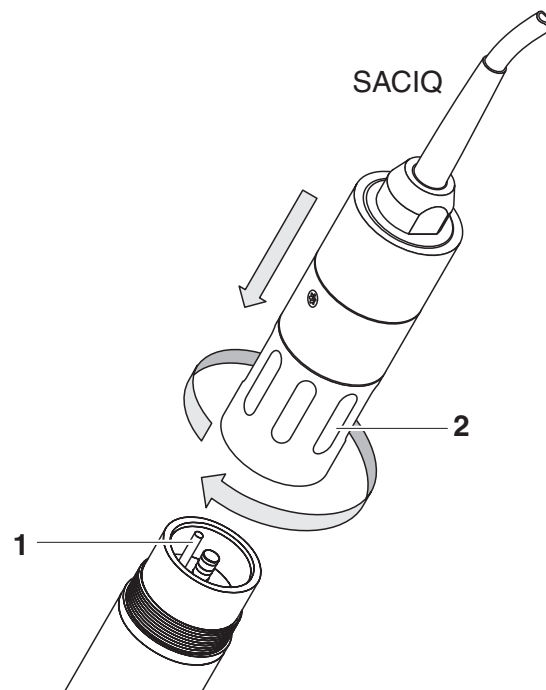

Fig. 3-5 Connect the sensor

1	Take the protective caps off the plug connections of the sensor and the SACIQ sensor connection cable, and keep them safe.
2	Plug the socket of the SACIQ sensor connection cable onto the plug head connector of the sensor. At the same time, rotate the socket so that the pin in the plug head connector (1) clicks into one of the two holes in the socket.
3	Then screw the coupling ring (2) of the sensor connection cable onto the sensor up to the stop.

### 3.5 Settings

#### 3.5.1 General information

##### Automatic electrode recognition

The AmmoLyt<sup>®Plus</sup> 700 IQ software automatically recognizes the built-in electrodes and checks the equipment for validity. Depending on the equipment, the following sensors can be displayed in the list of sensors:

sensor	Designation
AmmoLyt <sup>®Plus</sup> 700 IQ Ammonium sensor	<i>AmmoLyt+</i>
AmmoLyt <sup>®Plus</sup> 700 IQ potassium sensor *	<i>AmmoLyt+K</i>

\* see setting table of the sensor

##### Carrying out settings

Using <S>, switch from the measured value display to the main menu of the settings. Then navigate to the setting menu (setting table) of the sensor. The exact procedure is given in the relevant IQ SENSORNET system operating manual.

The setting tables of the sensors are described in the following chapters.

##### Sensor overlapping settings

Certain settings are sensor overlapping and can be made in any one of the setting tables. The setting is used by all sensors.

The sensor overlapping settings are:

- *Temperature mode (°C/°F)*
- *Temp. adjustment*

3.5.2 Setting table *AmmoLyt+* (ammonium sensor)

Menu item	Selection/Values	Explanations
<i>Measuring mode</i>	<ul style="list-style-type: none"> <li>● <i>NH4-N</i></li> <li>● <i>NH4</i></li> <li>● <i>mV</i></li> </ul>	Citation form of the mass concentration or voltage of the electrode.
<i>Measuring range</i> ( <i>Measuring mode: NH4-N</i> )	<ul style="list-style-type: none"> <li>● <i>AutoRange</i></li> <li>● <i>0.1 ... 100.0 mg/l</i></li> <li>● <i>1 ... 2000 mg/l</i></li> </ul>	2 measuring ranges can be selected. With <i>AutoRange</i> , the instrument automatically switches to the suitable measuring range.
<i>Measuring range</i> ( <i>Measuring mode: NH4</i> )	<ul style="list-style-type: none"> <li>● <i>AutoRange</i></li> <li>● <i>0.1 ... 129.0 mg/l</i></li> <li>● <i>1 ... 2580 mg/l</i></li> </ul>	2 measuring ranges can be selected. With <i>AutoRange</i> , the instrument automatically switches to the suitable measuring range.
<i>Measuring range</i> ( <i>Measuring mode: mV</i> )	<ul style="list-style-type: none"> <li>● <i>-2000 ... 2000 mV</i></li> </ul>	Fixed range

If the sensor is not equipped with a potassium electrode:

<i>Potassium compens.</i>	<i>Manual</i>	<p>After determining the potassium content of the test solution, enter the potassium content determined in the next line manually (<i>Potassium conc.</i>). The measured value is accordingly corrected by the entered potassium content.</p> <p><u>Note:</u> With the <i>Link (sensor to sensor)</i> function, the IQ SENSORNET is able to provide a measured value for the interfering ion.</p> <p><u>Note:</u> Detailed information on the subject of potassium compensation is given in the primer, ION SELECTIVE MEASUREMENT IN ONLINE ANALYSIS.</p>
<i>Potassium conc.</i>	<i>0.1 ... 1000 mg/l</i>	Manual input of the potassium value

Menu item	Selection/Values	Explanations
If the sensor is equipped with a potassium electrode:		
<i>VARiON K</i>	<ul style="list-style-type: none"> <li>● <i>hide</i></li> <li>● <i>show</i></li> </ul>	<p><i>hide</i> (standard setting): The potassium electrode is not displayed as an extra sensor in the measured value display. More settings are possible (see below).</p> <p><i>show</i>: If the sensor is equipped with the potassium electrode, the electrode is displayed as the extra sensor <i>VARiON K</i> in the measured value display. The relevant settings can be done in an extra setting table (see section 3.5.3). <u>Note</u>: If the maximum number of sensors for the system is exceeded by activating the sensor, the <i>VARiON K</i> cannot be activated.</p>
If the setting <i>VARiON K hide</i> was additionally selected:		
<i>Calib. history K</i>	<ul style="list-style-type: none"> <li>● <i>Do not download</i></li> <li>● <i>Transmit to log book</i></li> </ul>	The selection of <i>Transmit to log book</i> generates a log book message with the calibration history of the potassium electrode. When opening the setting table again the setting is reset to <i>Do not download</i> .
<i>Potassium compens.</i>	<i>Automatic</i>	When the potassium electrode is mounted, the potassium compensation takes places automatically only. The value of the potassium concentration measured at the time the setting table was opened is displayed in the next line ( <i>Potassium conc.</i> ).
<i>Potassium conc.</i>		Display of the measured potassium value ( <i>0.1 ... 1000 mg/l</i> ).
<i>Temperature mode</i> (only with <i>Measuring mode: NH4-N</i> or <i>NH4</i> )	<ul style="list-style-type: none"> <li>● °C</li> <li>● °F</li> </ul>	Unit of the measured temperature value (Celsius, Fahrenheit).

Menu item	Selection/Values	Explanations
<i>Temp. adjustment</i> (only with <i>Measuring mode: NH4-N or NH4</i> )	-1.5 °C ... +1.5 °C	The temperature compensation function enables the temperature sensor to be balanced against a reference temperature measurement (displacement of the zero point by ±1.5 °C). Notes: <ul style="list-style-type: none"> <li>● Due to the thermal capacity of the sensor, it is necessary to place it in a container with at least 2 liters of water.</li> <li>● Leave the sensor in this container for at least 15 minutes while stirring occasionally, then carry out the adjustment. If the temperature difference of the water and sensor is &gt; 10°C, leave the sensor in the container for at least one hour while stirring occasionally.</li> </ul>
<i>Conc. offset</i>	-1.0 mg/l ... +1.0 mg/l	Constant value that is added to the measured value.
<i>Save and quit</i>		The system confirms the saving of the settings and the display switches to the next higher level.
<i>Quit</i>		The display switches to the next higher level without storing the new settings.

### 3.5.3 Setting table *AmmoLyt+K* (potassium sensor)



These sensor settings are only available if in the sensor settings for the *AmmoLyt+* the setting *VARION K* was set to *Active* (see section 3.5.2).

The basic settings are taken over from the *AmmoLyt+* sensor but can be adjusted separately afterwards.

Menu item	Selection/Values	Explanations
<i>Measuring mode</i>	<ul style="list-style-type: none"> <li>● <i>K (mg/l)</i></li> <li>● <i>mV</i></li> </ul>	Citation form of the mass concentration or voltage of the electrode.
<i>Measuring range</i> <i>Measuring mode:</i> <i>K (mg/l)</i>	<ul style="list-style-type: none"> <li>● <i>AutoRange</i></li> <li>● <i>0.1 ... 100.0 mg/l</i></li> <li>● <i>1 ... 1000 mg/l</i></li> </ul>	Fixed range

Menu item	Selection/Values	Explanations
<i>Measuring range</i> <i>Measuring mode: mV</i>	● -2000 ... 2000 mV	Fixed range
<i>Temperature mode</i> (only with <i>Measuring mode: K (mg/l)</i> )	● °C ● °F	Unit of the measured temperature value (Celsius, Fahrenheit).
<i>Temp. adjustment</i> (only with <i>Measuring mode: K (mg/l)</i> )	-1.5 °C ... +1.5 °C	The temperature compensation function enables the temperature sensor to be balanced against a reference temperature measurement (displacement of the zero point by ±1.5 °C). Notes: ● Due to the thermal capacity of the sensor, it is necessary to place it in a container with at least 2 liters of water. ● Leave the sensor in this container for at least 15 minutes while stirring occasionally, then carry out the adjustment. If the temperature difference of the water and sensor is > 10°C, leave the sensor in the container for at least one hour while stirring occasionally.
<i>Conc. offset</i>	-10.0 mg/l ... +10. mg/l	Constant value that is added to the measured value.
<i>Save and quit</i>		The system confirms the saving of the settings and the display switches to the next higher level.
<i>Quit</i>		The display switches to the next higher level without storing the new settings.

## 4 Matrix adjustment, check and calibration

### 4.1 General information

#### Calibration free operation

The AmmoLyt<sup>®Plus</sup> 700 IQ sensor is immediately ready to measure after being equipped with electrodes. For precise measurements, it is only necessary to adjust the electrodes to the sample matrix ("matrix adjustment"). In the recommended application (see section 1.3 RECOMMENDED FIELDS OF APPLICATION), the measuring characteristics of the electrodes remain stable for their entire service life. Thus, calibration is not recommended.

Possible changes of the sample matrix can be determined by occasional comparison measurements (e.g. photometer) and compensated for by a new matrix adjustment as necessary. The sensor does not have to be taken out of the sample for this. At the same time, a matrix adjustment provides information on the state of the electrodes.

#### Drift potential:

Simultaneously with the matrix adjustment (or calibration), the drift voltage DV(mV) of the electrode is determined. It serves to evaluate the long-term behavior of the electrode. The drift voltage changes due to the following factors:

- Influences due to the sample composition (matrix)
- Changes of the electrode characteristic(s).

#### Zeroing

The temporal change of the drift voltage is recorded in the calibration history so the long-term behavior of a electrode can be evaluated. As a start value, the user has to set the drift voltage to zero (zeroing) at the beginning of this evaluation period in order to observe any changes in the calibration history.

The zeroing for an electrode is done within the *MATRIX ADJUSTMENT* or *CALIBRATION* procedure if the zeroing was selected for the electrode (checked off). It becomes effective if the procedure was successfully carried out.

Carry out the zeroing when commissioning the electrode so you can watch in the calibration history the entire working period of the electrode.

It is not possible to zero an electrode with the *CHECK* procedure, as this procedure stores no data in the sensor.

#### Resetting the slope with the zeroing

Zeroing with the *MATRIX ADJUSTMENT* procedure resets the slope to the default setting (+ or - 59.2 mV) at the same time. Zeroing with the *CALIBRATION* procedure replaces the existing slope with the newly determined value.



## 4.2 Matrix adjustment

### 4.2.1 General information on matrix adjustment

This procedure adjusts the value measured directly in the test sample to an independently determined reference value ("lab value"). To determine the reference values, a sample is taken from the measuring solution and the relevant concentrations are measured (e.g. photometrically).

First select for which of the installed electrodes the matrix adjustment should be carried out. Based on this selection and the electrode equipment, the sensor software determines the ion types for which a reference measurement must be carried out. The menu guided routine adapts itself correspondingly and informs you of all necessary actions.

### 4.2.2 Carrying out the matrix adjustment

#### Main steps

- Step 1:** Determination of all electrode voltages ("reference voltages"). The sensor is in the sample. The procedure is started from the measured value display with <C>. After completion the system returns to the measured value display.
- Step 2:** Sampling at the same place and time if possible and determination of all relevant reference values
- Step 3:** Entry and storage of the measured reference values. This step is started by pressing <C> again.

#### Online help

A convenient, menu guided routine guides you through the *MATRIX ADJUSTMENT* procedure. In addition, you can call up an *Online help* with <C> for each step. An info box with detailed information on the relevant operating step appears on the display. It provides, for example, important instructions on how to keep the correct basic conditions. When <OK> is pressed, the display returns to the current operating step.



Operation is different from the steps mentioned above if the sensor is operated either on the IQ SENSORNET system 182 or on the MIQ/MC controller.

Move the highlighting to the *Online help* menu item with the arrow keys <▲▼◀▶> or the toggle switch <▲▼> and press <OK>.

When <OK> is pressed once again, the display returns to the current operating step.

**Matrix adjustment with zeroing**

After installing a new or different electrode you have to zero the electrode to facilitate a long-term evaluation. Details on zeroing, see section 4.1.

**Practical instructions**

- Ammonium has to be determined immediately after taking the sample as its concentration changes very quickly due to the micro organisms that are present. It is best to take the sample immediately using a syringe filter for transport to the laboratory or to stabilize it otherwise. When adding stabilizing solutions, the dilution factor has to be taken into account.
- When determining the reference concentrations in the lab (step 2), you can use the sensor for control purposes at the same time. The sensor continues to use the data of the previous matrix adjustment (or calibration). The reference voltages determined in step 1 will not be lost. They remain stored until step 3 of the matrix adjustment is completed. They do not have to be noted and entered again.
- Use the *Online help* if you are unsure of anything during the matrix adjustment.

**4.2.3 Result of the matrix adjustment****Evaluation**

After the matrix adjustment, the system automatically evaluates the current condition of the electrode(s) based on the drift voltage. For a successful matrix adjustment, the drift voltage must be within the range -45 mV to +45 mV. The drift voltage is set to 0 mV if you have selected a zeroing.

At the end of the matrix adjustment procedure the drift voltage of all selected electrodes is shown on the display. The evaluation is indicated with a check mark (✓ = successful) or a minus sign ("- = not successful).

**Taking over the determined values**

For each successfully adjusted electrode you can individually decide whether the values should be stored for measurement.



If the matrix adjustment was erroneous due to an incorrect determination or entry of the reference concentration, you can correct the entry (if necessary several times). If, by doing so, it is not possible to eliminate the error, the complete matrix adjustment for this electrode has to be repeated or discarded. If it is discarded, measurement is continued with the values of the last valid matrix adjustment (or calibration). Values of successfully adjusted electrodes that were already stored are retained.



Actions for error elimination are given in the *Online help* and in chapter 8 WHAT TO DO IF ...

### Sensor history

The data of the matrix adjustment are available in the *Sensor history* (see section 4.4 SENSOR HISTORY).

### 4.2.4 Special functions

The simple matrix adjustment, as described in the sections 4.2.2 to 4.2.3, will in most cases lead to precise measurement results. In some cases, special effects in the matrix can cause the real characteristic curve of the ISE measurement to deviate from the factory characteristic curve. This can lead to measured values that are not precise enough.

After consultation with the service department, it is possible to provide special functions to adjust the sensor for use in a special sample matrix or special measurement conditions.

These special functions can be selected like the other procedures.

## 4.3 Check and calibration in standard solutions

### 4.3.1 General information on checking and calibrating

In addition to the comparison measurement or matrix adjustment under real measurement conditions, it is possible to check the function of the entire sensor in standard solutions. If necessary, you can also take over in the sensor the slope and potential level of the individual electrodes via an exact calibration in standard solutions. The slope will be retained with a future matrix adjustment if it is carried out without zeroing the electrode.



The long term stable VARION®Plus electrodes are calibration-free in the recommended application. A check in standard solutions is only of significance if all basic conditions (cleanness, conditioning etc.) are strictly kept.

Calibrating the sensor is neither necessary nor recommended.

Calibration can cause major measurement errors if the basic conditions are not sufficiently kept. After calibrating, a matrix adjustment in the sample is required in addition. Standard solutions do not correspond to any real test sample!

### When does a check or calibration make sense?

A check or calibration can be useful in the following special cases:

- If the measured values do not appear to be correct even after a careful matrix adjustment and if you suspect the electrode slopes to have changed
- If a new application is to be started whose sample composition considerably deviates from that of the recommended application (see section 1.3 RECOMMENDED FIELDS OF APPLICATION)
- Routinely within the framework of the company quality assurance

### Differences between CHECK and CALIBRATION

The check and calibration are carried out in two separate routines. The schema is the same with both routines: Two standard solutions with different concentrations are measured one after the other. The procedures *CHECK* and *CALIBRATION* differ as follows:

- **CHECK:**  
The basic conditions to be kept are less strict. It is suitable as a quick method to check whether the slope and potential level of the electrodes are within the allowed limits. The results are just for information. No characteristics or sensor settings are changed.
- **CALIBRATION:**  
For this procedure, the basic conditions must comply with very high requirements (longer conditioning times, discarding of the conditioning solution, temperature adjustment etc.). Correspondingly, it requires more time. The slope and drift voltage are exactly determined and evaluated. If the calibration was successful, the determined values can be taken over for measurement. The procedure can, however, be used as a mere check method. Calibration is documented in the calibration history and in the log book.



Calibration is neither necessary nor recommended for the sensor.

**Standard solutions**

For the procedures *CHECK* or *CALIBRATION*, the following standard solutions in the following order:

- VARI<sup>®</sup>ON/ES-2 (high concentration)
- VARI<sup>®</sup>ON/ES-1 (low concentration).

These standard solutions contain all ion types that come into question (ammonium and potassium) and are especially adapted to the AmmoLyt<sup>®Plus</sup> 700 IQ.

**Online help**

A comfortable, menu guided routine guides you through the procedure. In addition, you can call up an *Online help* with <C> for each step. An info box with detailed information on the relevant operating step appears on the display. It provides, for example, important instructions on how to keep the correct basic conditions. When <OK> is pressed, the display returns to the current operating step.



Operation is different from the steps mentioned above if the sensor is operated either on the IQ SENSORNET system 182 or on the MIQ/MC controller.

Move the highlighting to the *Online help* menu item with the arrow keys <▲▼◀▶> or the toggle switch <▲▼> and press <OK>.

When <OK> is pressed once again, the display returns to the current operating step.

**Calibration with zeroing**

After installing a new or different electrode you have to zero the electrode to facilitate a long-term evaluation. Details on zeroing, see section 4.1.

**Preparations and instructions on how to keep the basic conditions**

- Select a place where clean working conditions and a constant, sufficiently high temperature are granted (a room, e.g. laboratory). Temperatures under 10 °C extend the conditioning time considerably.
- Make sure the temperature of all components (sensor, standard solutions, containers, accessories etc.) is similar and constant. We recommend to store the standard solutions in the same place where the check or calibration is carried out.
- Use containers and accessories (beaker, stirring rod) that are absolutely clean and without detergent residues. Detergent residues can seriously affect the function of the electrodes.
- Remove the protective hood and clean the sensor thoroughly. Before the check, rinse the sensor with standard solution VARI<sup>®</sup>ON/ES-2.
- Make sure the depth of immersion is sufficient (minimum 5 cm).

- Make sure there are no air bubbles in front of the electrode membrane.
- Conditioning times: During the conditioning steps, all relevant electrode voltages are indicated on the display. Thus you can observe the conditioning process.
- Regular stirring accelerates the conditioning process considerably. Stirring with a stirring rod or the sensor itself is sufficient.
- For calibration, the standard solution is discarded after conditioning. This is pointed out by a corresponding note in the calibration routine. It is essential for an exact calibration result.
- Use the *Online help* if you are unsure of anything during calibration.

#### 4.3.2 Result of the check

##### Evaluation

At the end of the check, the result for the electrodes is shown on the display with "+" (successful) or "-" (unsuccessful). The exact check criteria are given in the *Online help* of the result display. At the same time the result is entered in the log book as an info message. There is no entry in the calibration history.

##### Sensor history

The result of the check is available in the *Sensor history* (see section 4.4 SENSOR HISTORY).

#### 4.3.3 Result of the calibration

##### Evaluation

With calibration, the system automatically evaluates the condition of an electrode based on the data of its characteristic curve. The drift potential and slope are evaluated separately. For a calibration procedure to be valid, the potential level, slope and drift voltage must be within certain ranges.

Valid ranges for slope and drift potential:

Value of the slope: 50 ... 70 mV

Drift voltage: -45 ... +45 mV

The valid potential levels (MIN, MAX) can be taken from the online help.

##### Taking over the determined values

For each successfully calibrated electrode you can individually decide whether the values should be stored for measurement.



Actions for error elimination are given in chapter 8 WHAT TO DO IF ...

**Sensor history**

The result of the calibration is available in the *Sensor history* (see section 4.4 SENSOR HISTORY).

**4.4 Sensor history**

The data of the calibration procedures and matrix adjustments are available in the Sensor history and in the calibration history.

The sensor history supplements and expands the calibration history:

- The results of any checks are displayed.
- All data of all electrodes of the sensor can be displayed in one list.
- More datasets can be displayed for each electrode.

**Sensor history**



The Sensor history and calibration history are not available if the sensor is operated either on the IQ SENSORNET System 182 or on the MIQ/MC controller.

- 1 In the measured value display, select the sensor with <▲▼> and use <C> to open the *PROCEDURE/SETTINGS* window for the sensor.
- 2 Select the menu *Sensor history*.
- 3 Select the electrodes that should be displayed in the *Sensor history*.
- 4 Follow the user guide.  
The *Sensor history* is displayed for the selected electrodes.



Using <S>, you can save the displayed Sensor history to a USB memory device connected (directory, VARiON).

**Calibration history**



The calibration history is not available if the sensor is operated on the IQ SENSORNET System 182.

- 1 In the measured value display, select the sensor with <▲▼> and confirm with <OK>. The *Anzeige/Optionen* menu pops up.
- 2 Display the individual calibration histories.

HIQ/T2020	05 Dec 2006	12 28						
Calibration history of selected sensor								330
SD1 AmmoLyt+		04460001						
Date	S	DV	Ref1	Ref2	K+	P	T	R
24.07.06	59.2*	0	2.7	-	14	1	12	+
05.12.06	59.2*	-3	2.6	-	11	1	8	+
27.10.06	59.2*	5	9.8	-	22	1	6	+
16.09.06	59.2*	2	4.7	-	15	1	7	+
02.08.06	59.2*	4	4.0	-	18	1	10	+
Return ESC								

Fig. 4-1 Calibration history with matrix adjustments (example: AmmoLyt+)

The calibration history provides the following information:

<b>Date</b>	Date of the calibration or matrix adjustment
<b>S</b>	Slope [mV] of the electrode. <u>Note:</u> After a matrix adjustment, the values for the slope are marked by a star (*) because they were not changed by this procedure.
<b>DV</b>	Drift voltage [mV] After zeroing and subsequent calibration or matrix adjustment, 0 is displayed.
<b>Ref1/Ref2</b>	Depending on the procedure. Matrix adjustment: Reference concentration [mg/l] Calibration: Standard solution used ( <i>ES1</i> , <i>ES2</i> )
<b>K+</b>	Depending on the procedure. Matrix adjustment: Interfering ions concentration [mg/l] Calibration: Standard solution, VARiON®/ES-2
<b>P</b>	Procedure (1 = matrix adjustment, 3 = calibration)
<b>T</b>	Temperature [°C]
<b>R</b>	Evaluation of the calibration or matrix adjustment + : Calibration or matrix adjustment. The sensor measures with the new calibration or adjustment data. ? : Calibration or matrix adjustment not accepted and not saved. Measurement is continued with the last valid values.





If the compensation electrode is displayed as an extra sensor, the calibration history of the compensation electrode can be viewed in the sensor menu of this sensor.

Log book messages are displayed with the main sensor. The IQ SENSORNET does not keep an extra log book for this sensor.

If the compensation electrode is not displayed as an extra sensor, you can, if required, generate a log book message with the calibration history via the menu item (*Calib. history K*) in the setting table of the relevant main sensor. The log book message is in the log book of the relevant main sensor (*AmmoLyt+* -> message code IC5395).

## 5 Measuring

### 5.1 Measurement operation

Note the data given in section 9.2 APPLICATION CONDITIONS, especially the minimum immersion depth of the sensor (> 50 mm with mounted protective hood).

#### NOTE

*Greases, oils, certain tensides and similar substances can shorten the operational lifetime of the electrodes. Therefore, they should not be present in the test sample(see section 3.3.1 EFFECTS TO BE GENERALLY AVOIDED).*



If necessary, the CH Cleaning head can be used to keep the sensor clean (see chapter 7 REPLACEMENT PARTS AND ACCESSORIES).

### 5.2 Factors affecting the measured value

Ammonium measurement with the AmmoLyt<sup>®Plus</sup> 700 IQ can be affected by the following variables:

- pH value
- Potassium ions



The effects of influencing variables on measurement and compensating actions are described in detail in the primer ION SELECTIVE MEASUREMENT IN ONLINE ANALYSIS.

## 6 Maintenance and electrode exchange

### 6.1 General maintenance instructions



#### WARNING

**Contact with the sample can be dangerous for the user! Depending on the type of sample, suitable protective measures must be taken (protective clothing, protective goggles, etc.).**

#### Maintenance condition

We recommend to switch on the maintenance condition each time the sensor is taken out of the measuring position. This avoids unwanted reactions of linked outputs. More detailed information on the maintenance condition is given in the respective IQ SENSORNET system operating manual.

#### VARiON<sup>®</sup>/Epack

The VARiON<sup>®</sup>/Epack set with usual replacement parts is available for maintenance (see chapter 7 REPLACEMENT PARTS AND ACCESSORIES).

### 6.2 Exterior cleaning



To keep the electrodes clean, we recommend to use the CH cleaning head (see chapter 7 REPLACEMENT PARTS AND ACCESSORIES).

With normal operation (e.g. municipal wastewater) we strongly recommend to clean the outside of the sensor:

- when it is strongly contaminated (after visual check)
- if erroneous measured values are suspected
- each time before removing or exchanging an electrode

#### NOTE

*Do not use any detergent or deionized water for cleaning. Heed the notes in section 3.3.1 EFFECTS TO BE GENERALLY AVOIDED.*



We recommend to clean the sensor shaft and electrodes while the sensor is still connected to the sensor connection cable. Otherwise, moisture and/or dirt can get into the plug connection where it can cause contact problems.

If you need to disconnect the sensor from the sensor connection cable, please note the following points:

- Before disconnecting the sensor from the SACIQ sensor connection cable, remove any larger pieces of contamination from the sensor, particularly in the area of the plug connection (brush it off in a bucket of tap water, wash it off with a hose or wipe it off with a cloth).

- Unscrew the sensor from the SACIQ sensor connection cable.
- Always place a protective cap on the plug head of the sensor and on the SACIQ sensor connection cable so that no moisture or dirt can get into the contacting surfaces.
- In corrosive environments, close the socket of the sensor connection cable with the screwable SACIQ-Plug when it is dry in order to protect the electrical contacts from corrosion. The protective plug is available as an accessory (see section 7.2 GENERAL ACCESSORIES).

**Cleaning the sensor**

Clean the sensor shaft with tap water and a soft sponge or brush. Remove the protective hood. The electrodes are best cleaned under running tap water using a soft toothbrush or brush.

**Cleaning the coupling ring of the protective hood**

The coupling ring can be unscrewed and dismantled for cleaning as follows:

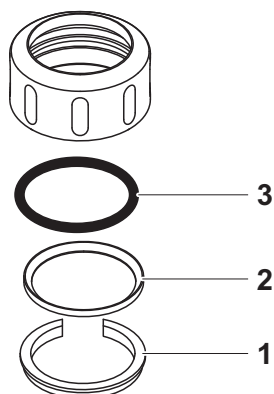

Fig. 6-1 Dismantling the coupling ring

1	Remove the retaining ring (pos. 1 in Fig. 6-1).
2	Remove the intermediate ring (pos. 2) and sealing ring (pos. 3).

After the parts have been cleaned, reassemble the coupling ring in reverse order. When doing so make sure that the tapered side of the intermediate ring (pos. 2) points towards the sealing ring (pos. 3).

### 6.3 Exchanging the electrodes



**NOTE**

*The sensor can be damaged by dirt and moisture. Each time before dismantling an electrode carefully clean the area around the electrodes (section 6.2). Before mounting an electrode make sure the area behind the sealing ring of the electrode and the receptacle are dry and clean. The AmmoLyt<sup>®Plus</sup> 700 IQ may only be submersed when the electrodes or original blind plugs are mounted.*

Use the special socket wrench provided to dismantle an electrode. Electrodes are installed as described in section 3.4.1 EQUIPPING THE SENSOR WITH ELECTRODES.

**Recognizing the electrode type from outside**

When mounted, the electrodes can be recognized by the following features:

Electrode	Hexagon	Front surface	Other features
VARiON <sup>®Plus</sup> Ref 	black	black	– Thread at the hexagon
VARiON <sup>®Plus</sup> NH4 	black	black	– Hexagon without thread
VARiON <sup>®Plus</sup> K 	black	white	



For the correct storage of the electrodes please follow the instructions in section 3.3 NOTES ON THE HANDLING OF THE ELECTRODES.

## 7 Replacement parts and accessories

### 7.1 Electrodes

Exchange electrodes	Description	Model	Order no.
	Reference electrode	VARiON®Plus Ref	107042
	Ammonium electrode	VARiON®Plus NH4	107044
	Potassium electrode	VARiON®Plus K	107046

Storing equipment	Description	Model	Order no.
	250 ml potassium chloride solution for storing the reference electrode	KCI-250	109705

### 7.2 General accessories

Standard solutions for calibration	Description	Model	Order no.
	1 liter combination standard 1 (low concentration)	VARiON®/ES-1	107050
	1 liter combination standard 2 (high concentration)	VARiON®/ES-2	107052

Maintenance equipment	Description	Model	Order no.
	Polishing strip	SF 300	203680

Protective plugs	Description	Model	Order no.
	Screwable plug for sensor connection cable	SACIQ-Plug	480065

General replacement parts	Description	Model	Order no.
	Protective hood	VARiON® 700 IQ-SK	107056

Description	Model	Order no.
Replacement parts set, comprising <ul style="list-style-type: none"> <li>– 1 blind plug for receptacle</li> <li>– 1 special socket wrench</li> <li>– 3 replacement sealing rings for electrodes/blind plugs</li> <li>– Storing equipment for electrodes:                             <ul style="list-style-type: none"> <li>1 nut (transparent),</li> <li>1 watering cap with sponge</li> <li>1 nut (black)</li> <li>1 watering cap (without sponge) for reference electrode</li> </ul> </li> </ul>	VARiON®/Epack	107057

**Components for cleaning system**

Description	Model	Order no.
Cleaning head	CH	900107
Passive valve module	DIQ/CHV	472007
Active valve module (does not require a free relay output in the IQ SENSORNET system)	MIQ/CHV PLUS	480018
Air compressor supplying the sensor cleaning system with cleaning air	Cleaning Air Box 115 VAC 230 VAC	480017 480019



Information on further IQ SENSORNET accessories is given in the catalog and on the Internet.

## 8 What to do if ...

### 8.1 Interpretation of the drift voltage

The drift voltage is influenced by the potential levels of the measurement electrode and reference electrode. If the potential levels shift, e.g. caused by aging, both parts can move into the same direction or into opposite directions. The comparison of the drift voltages of two or three electrodes enables to draw conclusions concerning the state of individual electrodes if a matrix adjustment or calibration resulted in an invalid or considerably deviating drift voltage.

#### Assessment aids

View the calibration history of the electrodes. In the following cases, assessment is relatively easy:

- If the drift voltages of all electrodes show the same trend, i. e. the drift voltages have shifted in the same direction (positive or negative) by approximately the same amount, this indicates that the potential level of the reference electrode has shifted. The reference electrode is possibly highly contaminated or at the end of its service life.
- If the drift voltages of all electrodes do not show a trend but shift by different amounts into different directions, the potential level of the reference electrode has not changed considerably. The invalid drift voltage is probably caused by a defective measuring electrode. The measuring electrode is possibly highly contaminated or at the end of its service life.



## 8.2 Error causes and remedies

<b>No measured value display</b>	<b>Cause</b>	<b>Remedy</b>
	– Sensor not connected	– Connect the sensor
	– Incorrect electrode equipment	– Correct electrode equipment
	– Electrode(s) not at all or incorrectly recognized by the system	– Check the installation and contacts of the electrode (gap-free mounting) – Check electrode receptacle for moisture – If necessary, unscrew the electrode/blind plug and thoroughly dry the electrode/blind plug and receptacle
	– Unknown	– Look for error messages in the log book
	– Liquid in the sensor shaft	– Contact the service department
<b>Measurement provides implausible measured values</b>	<b>Cause</b>	<b>Remedy</b>
	– No matrix adjustment carried out	– Carry out matrix adjustment
	– Error during matrix adjustment (e.g. incorrect laboratory values)	– Check the conditions of the matrix adjustment – Carry out new matrix adjustment
	– Calibration error (e.g. contaminated standard solutions)	– Check the calibration conditions – Recalibrate – Reset to default calibration
	– Manual interfering ions compensation works with an unsuitable value	– Determine and enter the interfering ions compensation once again

Cause	Remedy
– Electrode(s) not at all or incorrectly recognized by the system	<ul style="list-style-type: none"> <li>– Check the installation and contacts of the electrode (gap-free mounting)</li> <li>– Check electrode receptacle for moisture</li> <li>– If necessary, unscrew the electrode/blind plug and thoroughly dry the electrode/blind plug and receptacle</li> </ul>
– Electrode contaminated	– Clean the electrode (see section 6.2)
– Liquid in the sensor shaft	– Contact the service department

**Measurement provides jumping, unstable or drifting values**

Cause	Remedy
– Measurement / compensation electrode: Electrode membrane not moistened by measuring solution, e.g. due to air in front of the membrane (membrane dried up)	– Moisten membrane with deionized water using a wash bottle. To do so, position the opening of the wash bottle on the membrane and splash against the membrane vigorously
– Measurement / compensation electrode: Air bubble behind the membrane	– Hold the electrode in a vertical position with the membrane down and knock it on the side with the special socket wrench until the air bubble moves up
– Measurement electrode / compensation and reference electrode: Insufficient electrical contact in the electrode receptacle	<ul style="list-style-type: none"> <li>– Check the installation and contacts of the electrode (gap-free mounting)</li> <li>– Check electrode receptacle for moisture</li> <li>– If necessary, unscrew the electrode/blind plug and thoroughly dry the electrode/blind plug and receptacle</li> </ul>
– Reference electrode dried up	– Replace reference electrode
– Measurement / compensation electrode or reference electrode leaky or damaged	– Replace defective electrode
– Liquid in the sensor shaft	– Contact the service department

**Faulty result of the matrix adjustment**

Cause	Remedy
<ul style="list-style-type: none"> <li>– Error during procedure, e.g. incorrect lab values</li> </ul>	<ul style="list-style-type: none"> <li>– Check the basic conditions</li> <li>– Follow the practical notes on page 26 or in the <i>online help</i></li> <li>– Recalibrate</li> </ul>
<ul style="list-style-type: none"> <li>– Reference electrode or measurement electrode defective due to aging (see section 8.1)</li> </ul>	<ul style="list-style-type: none"> <li>– Replace defective electrode</li> </ul>

**Faulty result of calibration**

Cause	Remedy
<ul style="list-style-type: none"> <li>– Error during procedure, e.g. contaminated standard solutions</li> </ul>	<ul style="list-style-type: none"> <li>– Check the basic conditions</li> <li>– Follow the practical notes on page 29 or in the <i>online help</i></li> <li>– Recalibrate</li> </ul>
<ul style="list-style-type: none"> <li>– Reference electrode or measurement electrode defective due to aging (see section 8.1)</li> </ul>	<ul style="list-style-type: none"> <li>– Replace defective electrode</li> </ul>

## 9 Technical data

### 9.1 Measuring characteristics

**Measuring principle**

Potentiometric measurement by means of ion sensitive electrodes. Modular structure with jointly used reference electrode and ion sensitive electrodes. Integrated microprocessor electronics, screened 2-wire connection for power and data transmission.

**Measured parameters**

Main measured parameter	Ammonium
Secondary measured parameter	Temperature
Compensation parameter	Potassium (depending on the electrode equipment)

**Measuring ranges and resolution, Ammonium measurement**

Measuring mode	Measuring range	Resolution
NH4-N	0.1 ... 100.0 mg/l 1 ... 2000 mg/l	0.1 mg/L 1 mg/L
NH4	0.1 ... 129.0 mg/l 1 ... 2580 mg/l	0.1 mg/L 1 mg/L
mV	-2000 ... +2000 mV	1 mV

**Measuring ranges and resolution, Potassium measurement**

Measuring mode	Measuring range	Resolution
K	0.1 ... 100.0 mg/l 1 ... 1000 mg/l	0.1 mg/L 1 mg/L
mV	-2000 ... +2000 mV	1 mV

**Interfering ions compensation**

Main measured parameter	Interfering ions that can be compensated for
Ammonium	Potassium (K <sup>+</sup> )

Selectable procedures for interfering ions compensation	Compensation procedures	Description
	Automatic	up to 1000 mg/l interfering ions when equipped with the corresponding compensation electrode
	Manual	without compensation electrode by manual entry of the interfering ions concentration (range 0.1 ... 1000 mg/l). <u>Note:</u> With the <i>Link (sensor to sensor)</i> function, the IQ SENSORNET is able to provide a measured value for the interfering ion.
Temperature measurement	Sensing element type	integrated NTC
	Measuring range	- 5 °C ... + 60 °C (23 ... 140 °F)
	Accuracy	± 0.5 K
	Resolution	0.1 K
	Response time t <sub>95</sub>	< 20 s
Temperature compensation	Automatic in the range 0 °C ... 40 °C (32 ... 104 °F)	

### 9.2 Application conditions

<b>Allowed temperature range</b>	Measuring medium	0 °C ... 40 °C (32 ... 104 °F)
	Storage/transport	0 °C ... 40 °C (32 ... 104 °F)
<b>Allowed pH range of the measuring medium</b>	4 ... 12	
<b>Pressure resistance</b>	Sensor with the electrodes or blind plugs screwed in and the SACIQ sensor connection cable connected:	
	Max. admissible overpressure	2 x 10 <sup>4</sup> Pa (0.2 bar)
<b>Type of protection</b>	Sensor with the electrodes or blind plugs screwed in and the SACIQ sensor connection cable connected: IP 68, 0.2 bar (2 x 10 <sup>4</sup> Pa)	
<b>Immersion depth</b>	min. 50 mm; max. 2 m depth	
<b>Operating position</b>	Electrode support pointing downward (maximum angle to the plumb line = 60 °)	
<b>Field of application</b>	<ul style="list-style-type: none"> <li>● Control / monitoring in the aeration tank of a waste water treatment plant</li> <li>● Water and waste water monitoring</li> </ul>	

### 9.3 General data

**Dimensions**

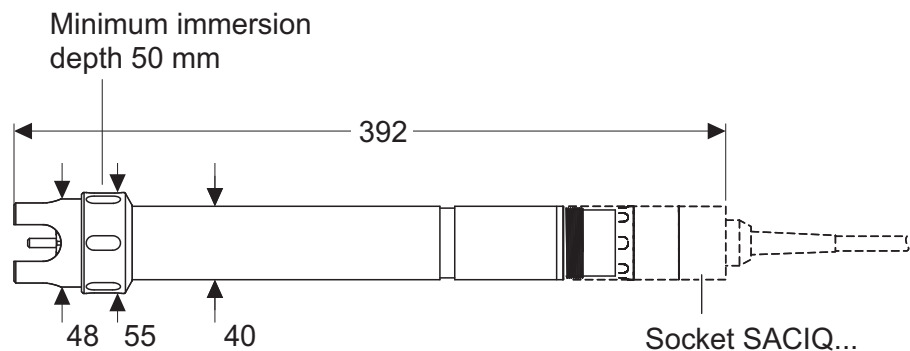

**Weight (without sensor connection cable)**

approx. 670 g with protective hood

**Connection technique**

Connection via SACIQ sensor connection cable

<b>Material</b>	Shaft	V4A stainless steel 1.4571
	Protective hood	POM
	Electrode support	POM
	Temperature sensor	V4A stainless steel 1.4571
	Plug head connector housing	POM
	Plug, 3-pole	ETFE (blue) Tefzel <sup>®</sup>
	Electrodes	see section 9.5

**NOTE**

*Stainless steel can be sensitive to corrosion with chloride concentrations from  $\geq 500$  mg/l.*

<b>Meter safety</b>	Applicable norms	<ul style="list-style-type: none"> <li>– EN 61010-1</li> <li>– UL 3111-1</li> <li>– CAN/CSA C22.2 No. 1010.1</li> </ul>
---------------------	------------------	---

**9.4 Electrical data**

Nominal voltage	Max. 24VDC via the IQ SENSORNET (for more details, see chapter TECHNICAL DATA of the IQ SENSORNET system operating manual)
Power consumption	0.2 W
Protective class	III

## 9.5 Data of the VARiON®Plus electrodes

### 9.5.1 Response times

	VARiON®Plus NH4	VARiON®Plus K
Response time $t_{90}$	< 3 min	< 3 min
Measured at 20 °C (68 °F) and a concentration change of ...	10 to 100 mg/l NH4-N	5 to 50 mg/l K

### 9.5.2 Materials

	VARiON®Plus NH4	VARiON®Plus K	VARiON® Ref
<i>Electrodes</i>			
Enclosure	POM	POM	PVC
Clamping ring	POM	POM	-
Membrane	soft PVC with stainless steel protective grating	soft PVC with stainless steel protective grating	-
Junction	-	-	Porous PVDF
Sealing ring	FPM (Viton®)	FPM (Viton®)	FPM (Viton®)
Connection contacts	gold-plated	gold-plated	gold-plated

#### *Storing equipment*

Watering cap	POM	POM	POM
Nut	PMMA	PMMA	POM

### 9.5.3 Weights

VARiON®Plus NH4	VARiON®Plus K	VARiON® Ref
5 g	5 g	13 g



## 10 Contact Information

### 10.1 Ordering & Technical Support

Telephone: (800) 897-4151  
(937) 767-7241  
Monday through Friday, 8:00 AM to 5:00 PM ET

Fax: (937) 767-1058

Email: [environmental@ysi.com](mailto:environmental@ysi.com)

Mail: YSI Incorporated  
1725 Brannum Lane  
Yellow Springs, OH 45387  
USA

Internet: [www.ysi.com](http://www.ysi.com)

When placing an order please have the following information available:

YSI account number (if available)	Name and Phone Number
Model number or brief description	Billing and shipping address
Quantity	Purchase Order or Credit Card

### 10.2 Service Information

YSI has authorized service centers throughout the United States and Internationally. For the nearest service center information, please visit [www.ysi.com](http://www.ysi.com) and click 'Support' or contact YSI Technical Support directly at 800-897-4151.

When returning a product for service, include the Product Return form with cleaning certification. The form must be completely filled out for an YSI Service Center to accept the instrument for service. The Product Return form may be downloaded at [www.ysi.com](http://www.ysi.com) and clicking on the 'Support' tab.

## 11 Indexes

### 11.1 Explanation of the messages

This chapter contains a list of all the message codes and related message texts that can occur in the log book of the IQ SENSORNET system for the AmmoLyt<sup>®Plus</sup> 700 IQ sensor.



Information on

- the contents and structure of the log book and
- the structure of the message code

is given in the LOG BOOK chapter of the IQ SENSORNET system operating manual.



The last three digits of the message code identify the source of the message:

- 521 = AmmoLyt+700IQ (Armature / component class, adapters ADA)
- 395 = AmmoLyt+ (Ammonium / potassium electrode)
- 397 = AmmoLyt+ (Potassium electrode)

#### 11.1.1 Error messages

<b>Message code</b>	<b>Message text</b>
EA1395	<i>Meas. range exceeded or undercut</i> * <i>Check process</i> * <i>Select other meas. range</i>
EA2521	<i>Sensor temperature too high!</i> * <i>Check process and application</i>
EA3521	<i>Sensor temperature too low!</i> * <i>Check process and application</i>
EAN395	<i>Potassium measurement: range exceeded or undercut</i> * <i>Check process</i>
EIA521	<i>Incorrect equipment</i> * <i>for correct electrode equipment see operating manual</i>
ES1521	<i>Component hardware defective</i> * <i>Contact service</i>

#### 11.1.2 Informative messages

Message code	Message text
IC3395	<i>K electrode has been successfully calibrated</i> <i>* For calibration data, see calibration history</i>
IC5395	(This message contains calibration data of the potassium electrode)
IC7395	<i>Sensor could not be calibrated,</i> <i>Measuring with old calibration values</i> <i>* Check calibration conditions and calibration standard</i> <i>* View calibration history</i> <i>* Service sensor immediately</i> <i>(see operating manual)</i>
ICA395	<i>Electrode: check successful</i>
ICB395	<i>K electrode: check successful</i>
ICD395	<i>Electrode: check unsuccessful</i> <i>Please follow online help.</i>
ICE395	<i>K electrode: check unsuccessful</i> <i>Please follow online help.</i>
IIA521	(This message is generated when the electrode equipment is changed. It informs you of the new assignment of the electrode receptacles)
IAI397	<i>see VARION A</i>
IAI398	<i>see VARION N</i>
ICY395	<i>AmmoLyt+:</i> Data of the last matrix adjustment or the last calibration

### 11.2 Status info

The status info is a coded piece of information on the current status of a sensor. Each sensor sends this status info to the controller. The status info of sensors consists of 32 bits, each of which can have the value 0 or 1.

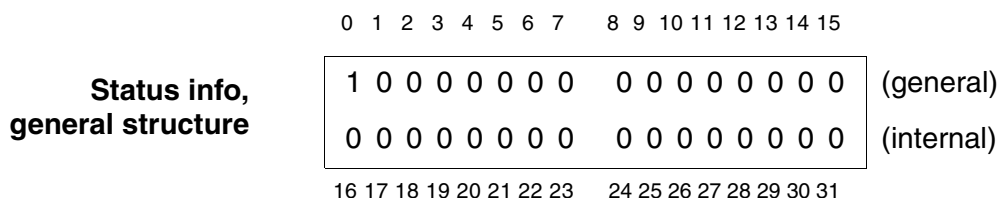

The bits 0 - 15 are reserved for general information.  
The bits 16 - 21 are reserved for internal service information.

You obtain the status info:

- via a manual query in the *Settings/Service/List of all components* menu (see system operating manual)
- by an automated query
  - from a superordinate process control (e. g. when connected to the Profibus)
  - of the IQ Data Server (see operating manual of the IQ SENSORNET software pack)



The evaluation of the status info, e.g. in the case of an automated query, has to be made individually for each bit.

**Status-Info**  
AmmoLyt<sup>®Plus</sup> 700 IQ

<b>Status bit</b>	<b>Explanation</b>
<b>Bit 0</b>	<i>Component hardware defective</i>
<b>Bit 1-31</b>	-



# Xylem |'zīləm|

- 1) The tissue in plants that brings water upward from the roots;
- 2) a leading global water technology company.

We're 12,500 people unified in a common purpose: creating innovative solutions to meet our world's water needs. Developing new technologies that will improve the way water is used, conserved, and re-used in the future is central to our work. We move, treat, analyze, and return water to the environment, and we help people use water efficiently, in their homes, buildings, factories and farms. In more than 150 countries, we have strong, long-standing relationships with customers who know us for our powerful combination of leading product brands and applications expertise, backed by a legacy of innovation.

**For more information on how Xylem can help you, go to [www.xylem.com](http://www.xylem.com)**



a **xylem** brand

YSI  
1725 Brannum Lane  
Yellow Springs, OH 45387  
Tel: +1 937-767-7241; 800-765-4974  
Fax: +1 937-767-1058  
Email: [environmental@ysi.com](mailto:environmental@ysi.com)  
Web: [www.ysi.com](http://www.ysi.com)

©Xylem Inc